

# ***XTRA.BEACON***

User Manual

Article No. 200.727

Document version: 1.3  
Date: 2022-10-26

## Copyright

The information in this document is subject to change without notice. Any trademarks, trade names, service marks or service names owned or registered by any other company and used in this manual are property of the respective companies.

Copyright 2022

De Haardt bv  
Marithaime 6  
6662 WD Elst (Gld)  
The Netherlands  
Tel.: +31 481 353 202  
Email: [info@de-haardt.com](mailto:info@de-haardt.com)

All rights reserved.

## Safety

All De Haardt's products are designed as supplement to make karting safer, but cannot replace safe track procedures. If equipment fails, the normal operating procedure must still be adequate to safely operate the track.

This document has been written with great care. However, the manufacturer cannot be held responsible, either for any errors occurring in this publication or for their consequences.

# Table of Contents

<b>1</b>	<b>GETTING STARTED .....</b>	<b>4</b>
1.1	WHAT IS IN THE BOX.....	4
1.2	INSTALLATION.....	7
1.2.1	Placement.....	8
1.2.2	Mounting.....	9
1.2.3	Connecting .....	10
<b>2</b>	<b>OPERATION.....</b>	<b>12</b>
2.1	OVERVIEW .....	12
2.2	INDICATION LEDs.....	12
2.2.1	Power .....	12
2.2.2	Ethernet.....	12
2.3	OLED DISPLAY .....	12
2.3.1	Sector number (default).....	12
2.3.2	Function number .....	13
2.3.3	Error code.....	13
2.3.4	IP address .....	13
2.3.5	Version number.....	13
2.3.6	Screensaver .....	13
2.4	SOFTWARE INTERFACE/ADVANCED MANUAL.....	13
<b>3</b>	<b>CONFIGURATION.....</b>	<b>14</b>
3.1	CONFIGURATION USING MAGNET TIP PEN .....	14
3.1.1	Sector number.....	14
3.1.2	Function number .....	14
3.2	ACCESSING THE WEB INTERFACE .....	15
3.3	USING THE WEB INTERFACE .....	15
3.3.1	Home .....	16
3.3.2	Setup .....	17
3.3.3	Change the LAN settings .....	18
3.3.4	Change the Xtra.Beacon settings .....	19
3.3.5	Run Time Statistics .....	20
3.3.6	System Tools .....	21
<b>4</b>	<b>TECHNICAL SPECIFICATIONS .....</b>	<b>24</b>
4.1	SPECIFICATION OVERVIEW .....	24
4.2	WATER AND DUST RESISTANCE .....	24
4.3	POWER OVER ETHERNET .....	24
<b>5</b>	<b>SUPPORT .....</b>	<b>25</b>

# 1 Getting started

This manual provides one with all the information needed to install, configure and use the Xtra.Beacon.

## 1.1 What is in the box

Before proceeding, make sure the box contains the following items:

### 1. Xtra.Beacon



Figure 1 - Xtra.Beacon

### 2. 5-meter-long Ethernet cable with a waterproof connector on one side



Figure 2 - Ethernet cable

### 3. Power over Ethernet injector



Figure 3 - Power over Ethernet injector

### 4. Magnet tip pen



Figure 4 Magnetic tip pen

**5. 25 -meter-long loop cable with 2x heat shrink**



*Figure 5 Loop with heat shrinks*

## 1.2 Installation

The Xtra.Beacon can be used to divide a track in multiple sectors. Each sector provides the transponder with different speed settings. Before installing the Xtra.Beacon it is important to determine the location of the desired sectors.

The Xtra.Beacon can be used to:

1. Divide a track in sectors and slow go-karts down at dangerous sections of a track.
2. Automatically slow go-karts down when entering the pitlane.
3. Automatically speed up go-karts when leaving the pitlane.
4. Measure lap times.



It is possible to use functions 1 and 4 of the Xtra.Beacon simultaneously.

### 1.2.1 Placement

The Xtra.Beacon can be installed in various combinations. Figure 6 describes multiple possible Xtra.Beacon locations. Each red line is a beacon loop. When an Xtra.Beacon just for timing, only one Xtra.Beacon is required on the start/finish line.

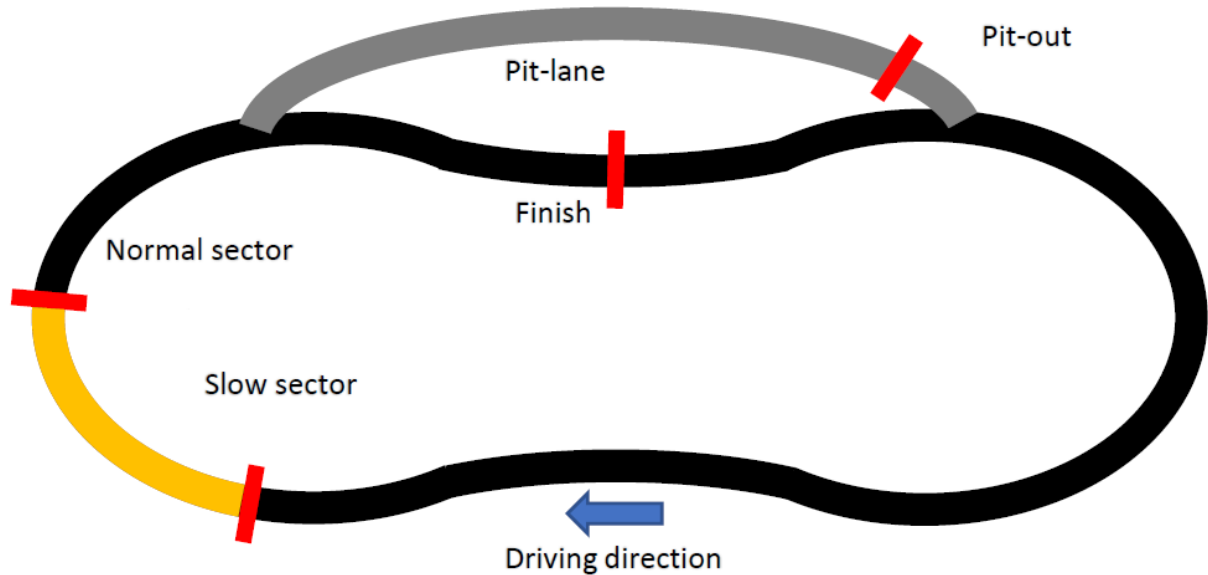

Figure 6 - Possible beacon locations

Whether a location is suitable for placing an Xtra.Beacon depends on the presence of metal. A beacon loop must be clear of metal around the track, otherwise the Xtra.Beacon signal can be detected in undesired locations on the track.

Once the Xtra.Beacon locations have been determined, the loops can be installed. Each loop requires a rectangular groove to be cut in the track surface. This groove must be 10mm deep and 3mm wide as shown in figure 8.

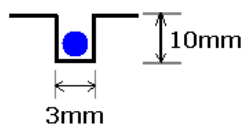

Figure 8 - Groove dimensions

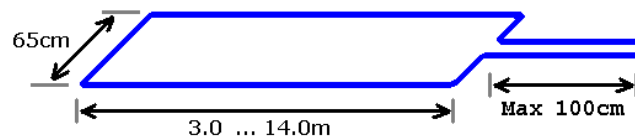

Figure 7 - Loop dimensions

Figure 77 describes the desired loop dimensions. When these dimensions are not met, the correct operation of the Xtra.Beacon cannot be guaranteed.

After the loops are installed on the track, the loop can be connected to the beacon using Faston terminals.



## 1.2.2 Mounting

The Xtra.Beacon can be mounted through the four M5 holes. The Xtra.Beacon can be mounted in all orientations as long as no metal objects are in the vicinity of the loop.

### 1.2.3 Connecting

This chapter describes how to connect the Xtra.Beacon.

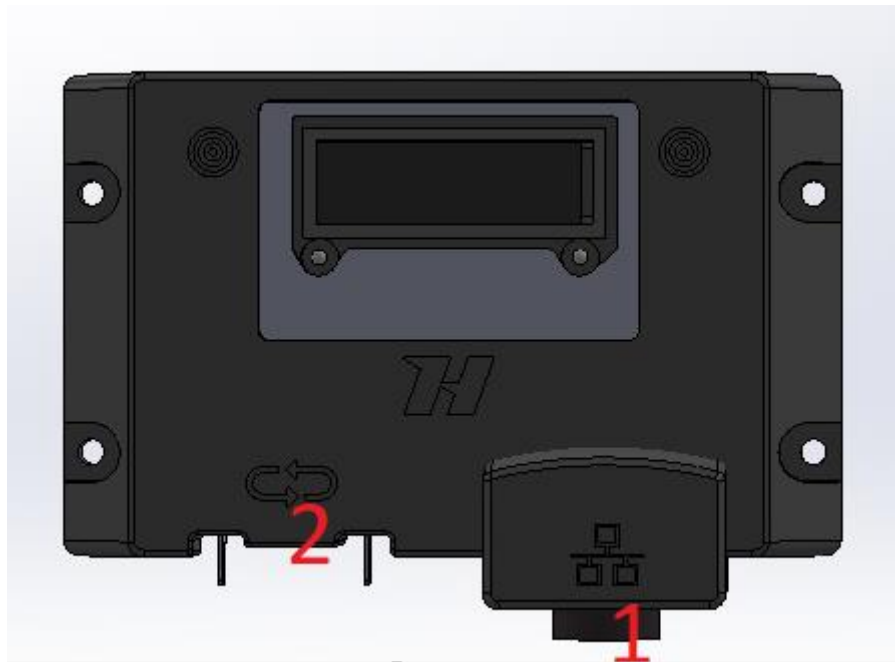

Figure 9 - Xtra.Beacon placeholder

1. **Ethernet connector:** Used to provide power to the Xtra.Beacon through power over Ethernet and may also be used for Ethernet communication. The waterproof connector of the supplied Ethernet cable must be connected to this connector and the other end of the cable must be connected to the port labeled OUT on the power over Ethernet injector.
2. **FASTON 250 terminals:** Used to connect the loop with the Xtra.Beacon.



Figure 10 - Power over Ethernet injector

The power over Ethernet injector features two ports labeled IN and OUT. The port labeled OUT should be used to connect the power over Ethernet injector to the Xtra.Beacon using the supplied Ethernet cable. The port labeled IN may be used to provide the Xtra.Beacon with access to an Ethernet network by connecting the port to a network router or switch using an Ethernet cable.



For the power over Ethernet injector to function, it must be plugged into a wall socket.

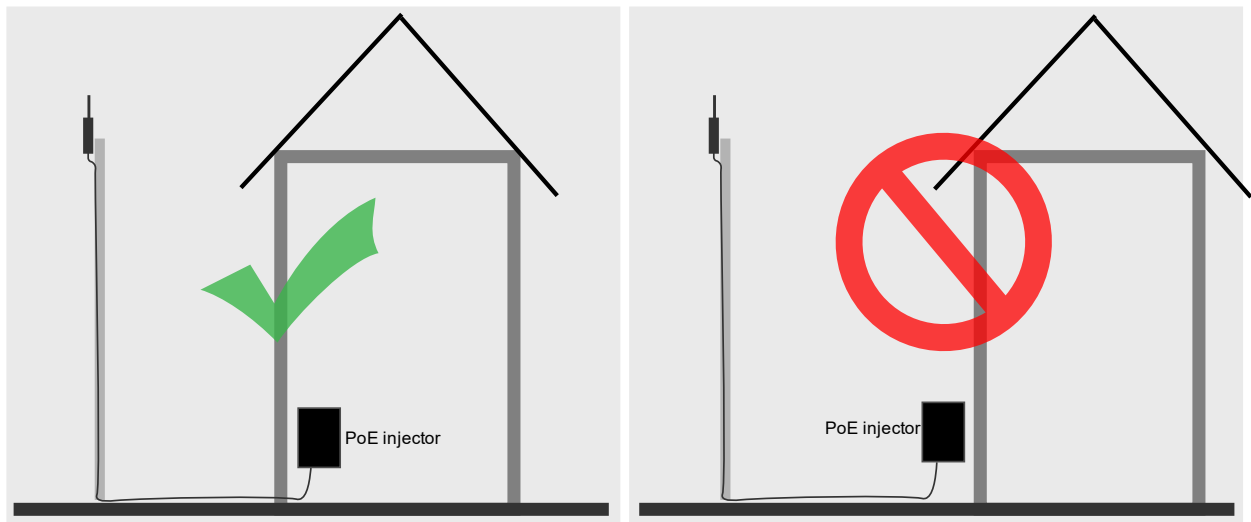

Figure 11 - Protect the power over Ethernet injector from water



The side of the supplied Ethernet cable that connects to the power over Ethernet injector as well as the power over Ethernet injector itself are **NOT waterproof**. Make sure these are protected from water!

## 2 Operation

### 2.1 Overview

The front of the Xtra.Beacon is provided with 2 LEDs: power, Ethernet and an OLED display.



Figure 12 - Front sticker with indication LEDs

### 2.2 Indication LEDs

This section describes what the 2 LEDs on the front of the Xtra.Beacon indicate.

#### 2.2.1 Power

The first led indicates if the Xtra.Beacon is powered or not.

LED Color	Description
Red	Xtra.Beacon is powered. <b>The device is ON</b>
Orange	Boot indication. <b>The device is starting up.</b>
OFF	Xtra.Beacon is not powered. <b>The device is OFF</b>

#### 2.2.2 Ethernet

The second led indicates if there is an Ethernet connection. If the LED is blinking fast, then there is a lot of communication.

LED Color	Description
Red	Ethernet is linked
Flash red	Ethernet link and Ethernet activity/send or receive Ethernet data
OFF	No Ethernet connection

### 2.3 OLED display

This section describes what information the OLED display on the front of the Xtra.Beacon can indicate.

A menu is embedded in the Xtra.Beacon. The subsections of this menu are described in the sections below.

The magnet tip pen must be used to navigate through this menu. The next submenu is displayed when the left cross is tapped with the magnet tip pen.

#### 2.3.1 Sector number (default)

When the Xtra.Beacon is powered on and no errors are detected, this screen will be shown. The screen displays the sector number to which the Xtra.Beacon is set in the format **"SN:XX"** with "XX" being the sector number.

### 2.3.2 Function number

The next section in the menu is function number. This screen displays the function number the Xtra.Beacon is set to. The information is displayed in the format **"FN:XX"** with "XX" being the function number.

### 2.3.3 Error code

This section in the menu displays the error code present on the Xtra.Beacon. When an error code exists in the beacon this screen will be shown on startup. The data is displayed in the format **"ER:XX"** with "XX" being the error code. The possible error codes are described in the table below:

Error code	Description
00	No errors detected.
01	Loop not connected.
02	Loop too long.
03	Loop too short.

### 2.3.4 IP address

When this section is selected the display will first show the text "IP-address" for 2 seconds. After this time the IP address will be displayed I.E. "192.168.1.123"

### 2.3.5 Version number

When this section is selected the display will first show the text "Version number" for 2 seconds. After this time the version number and revision will be displayed.

### 2.3.6 Screensaver

To prevent the OLED display from burning in, a screensaver has been implemented. When the Xtra.Beacon has had no interaction through the magnet tip pen for four hours, the screensaver will be activated. When the screensaver is active, a single pixel of the display will move around on the display.

## 2.4 Software interface/advanced manual

Please contact [support@de-haardt.com](mailto:support@de-haardt.com) for the advanced manual.

## 3 Configuration

The Xtra.Beacon can be configured in two ways, this being: using the supplied magnet tip pen, or using the web interface some settings can only be changed in the web interface. This chapter describes how to configure the Xtra.Beacon using the magnet tip pen, and how to access the web interface and what the different settings are.

### 3.1 Configuration using magnet tip pen

#### 3.1.1 Sector number

To change the sector number in the Xtra.Beacon the menu must be set to sector number. This can be done by tapping the left cross on the front of the Xtra.Beacon with the magnet tip pen until "SN:XX" is shown on the screen. Next the magnet tip pen can be held on the right cross for two seconds. After this time the number on the screen will start blinking. This means the setting can be changed. The settings can be changed in increments of 1 by tapping the magnet tip pen on the right cross. When the magnet tip pen is held on the right cross the setting will keep increasing until the magnet tip pen is removed from the cross.

Once the desired sector number is shown on the screen, it can be set by holding the magnet tip pen on the left cross for two seconds. When the number stops blinking the setting is saved.

Sector numbers range from 0 to 31.

#### 3.1.2 Function number

To change the function number in the Xtra.Beacon the menu must be set to function number. This can be done by tapping the left cross on the front of the Xtra.Beacon with the magnet tip pen until "FN:XX" is shown on the screen. Next the magnet tip pen can be held on the right cross for two seconds. After this time the number on the screen will start blinking. This means the setting can be changed. The settings can be changed in increments of 1 by tapping the magnet tip pen on the right cross. When the magnet tip pen is held on the right cross the setting will keep increasing until the magnet tip pen is removed from the cross.

Once the desired function number is shown on the screen, it can be set by holding the magnet tip pen on the left cross for two seconds. When the number stops blinking the setting is saved.

Function numbers range from 0 to 63.



More information about the different sector- and function number, and possible use-cases for the Xtra.Beacon can be found in the document Xtra Sector – Track configurations.

This document can be found on <https://www.de-haardt.com/downloads/>.



Due to a small error in the housing production of the Xtra.Beacon the crosses are misplaced by 8mm. Therefore the magnet tip pens must be placed 8mm to either the left or the right side of the cross. This does not affect the functioning of the Xtra.Beacon in any way.

## 3.2 Accessing the web interface

The web interface can be accessed using any device featuring a web browser. When the IP address of the Xtra.Beacon is entered into the address bar of a web browser, the products web interface will appear. If the IP address is unknown, the web interface can also be accessed through File Explorer on a Windows computer or by navigating to the IP address screen on the Xtra.Beacon using the magnet tip pen.

 To be able to access the web interface, the Xtra.Beacon should be connected to the same Ethernet network as the device you are trying to access the web page from.

To access the web interface through windows File Explorer, follow the steps below:

1. Press **Windows Key + E** on your keyboard to open **File Explorer**
2. Use the navigation pane on the left to open the **Network Tab**
3. In the **Other Devices** category, the Xtra.Beacon appears as in figure 12.
4. Double clicking the Xtra.Beacon will open the web interface using the default web browser.

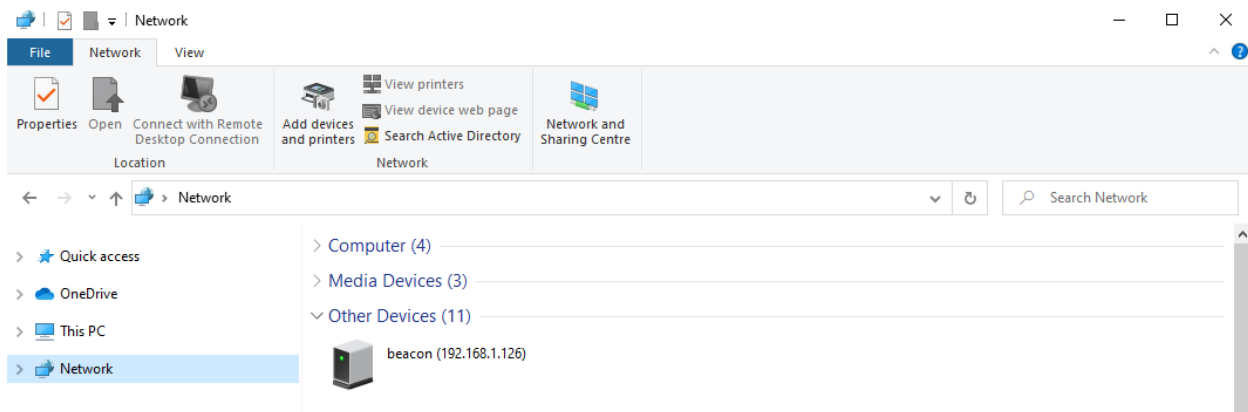



Figure 13 - Network Tab of File Explorer (Windows 10)

 A firewall may hinder the detection of the Xtra.Beacon and therefore prevent the product from appearing in the Network Tab of File Explorer.

## 3.3 Using the web interface

The web interface is divided into 4 webpages:

1. **Home:** Provides an overview of the active general settings.
2. **Setup:** Allows the user to change the settings of the Xtra.Beacon.
3. **Run Time Statistics:** Provides statistics for support purposes.
4. **System Tools:** Allows the user to perform a firmware update.

The navigation bar on the left side of the web interface can be used to switch between the 4 web pages.

### 3.3.1 Home

The home webpage provides an overview of the active general settings. The current LAN and Beacon settings are displayed here. For further explanation about these settings, see [3.2.2 Setup](#). The home webpage also displays the firmware version, hardware version and serial number of the Xtra.Beacon.

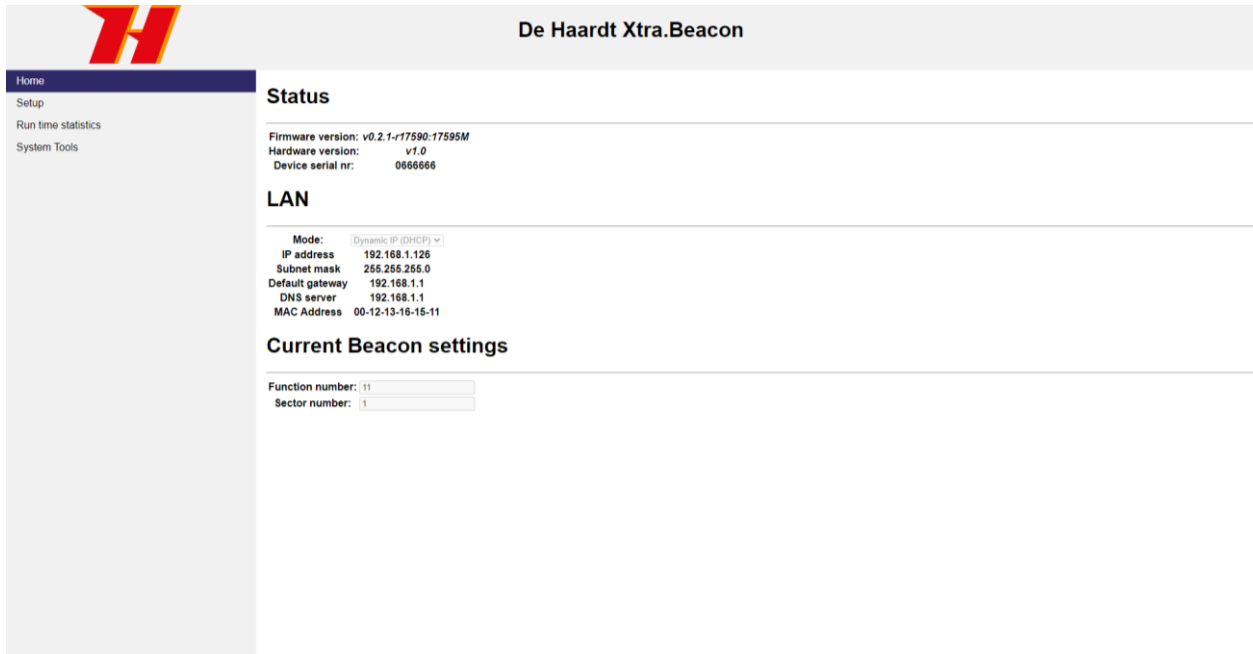

The screenshot shows the home webpage of the De Haardt Xtra.Beacon. The page has a header with the De Haardt logo and the title "De Haardt Xtra.Beacon". On the left side, there is a navigation menu with the following items: Home (selected), Setup, Run time statistics, and System Tools. The main content area is divided into three sections: Status, LAN, and Current Beacon settings. The Status section displays the following information: Firmware version: v0.2.1-r17590-17595M, Hardware version: v1.0, and Device serial nr: 0666666. The LAN section displays the following information: Mode: Dynamic IP (DHCP), IP address: 192.168.1.126, Subnet mask: 255.255.255.0, Default gateway: 192.168.1.1, DNS server: 192.168.1.1, and MAC Address: 00-12-13-16-16-11. The Current Beacon settings section displays the following information: Function number: 11 and Sector number: 1.

Status	
Firmware version:	v0.2.1-r17590-17595M
Hardware version:	v1.0
Device serial nr:	0666666

LAN	
Mode:	Dynamic IP (DHCP)
IP address	192.168.1.126
Subnet mask	255.255.255.0
Default gateway	192.168.1.1
DNS server	192.168.1.1
MAC Address	00-12-13-16-16-11

Current Beacon settings	
Function number:	11
Sector number:	1

Figure 14 - Home webpage



### 3.3.2 Setup

The setup webpage allows the user to change the settings of the Xtra.Beacon.

The webpage is divided into 2 sections:

1. **LAN:** Change the LAN settings.
2. **Beacon settings:** Change the settings of the Xtra.Beacon.

Each section will be explained separately in this paragraph. The setup webpage also displays the firmware version, hardware version and serial number of the Xtra.Beacon.

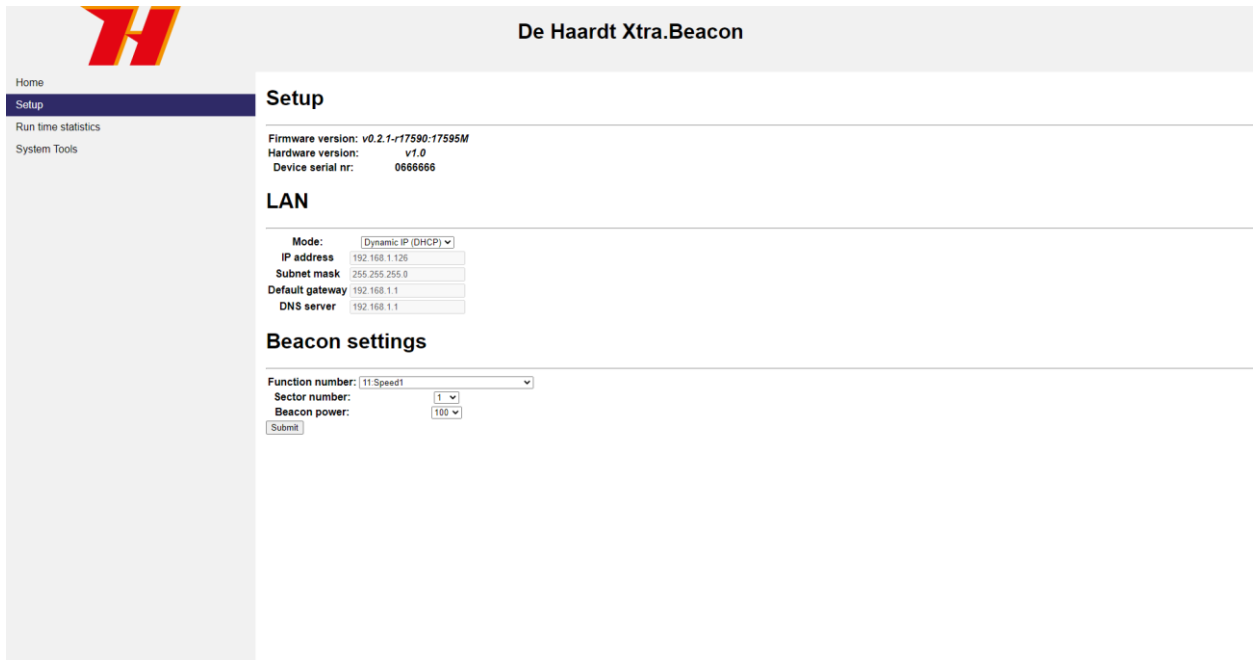

The screenshot shows the 'Setup' webpage for the De Haardt Xtra.Beacon. The page has a header with the De Haardt logo and the title 'De Haardt Xtra.Beacon'. A left sidebar contains navigation links: 'Home', 'Setup' (highlighted), 'Run time statistics', and 'System Tools'. The main content area is titled 'Setup' and displays the following information:

- Firmware version:** v0.2.1-r17590-17595M
- Hardware version:** v1.0
- Device serial nr:** 0666666

Below this is the 'LAN' section, which includes a 'Mode' dropdown menu set to 'Dynamic IP (DHCP)'. Below the mode are four input fields: 'IP address' (192.168.1.126), 'Subnet mask' (255.255.255.0), 'Default gateway' (192.168.1.1), and 'DNS server' (192.168.1.1).

The 'Beacon settings' section includes a 'Function number' dropdown menu set to '11.Speed1', a 'Sector number' dropdown menu set to '1', and a 'Beacon power' dropdown menu set to '100'. A 'Submit' button is located at the bottom of this section.

Figure 15 - Setup webpage

### 3.3.3 Change the LAN settings

In the LAN section, two modes can be selected: Dynamic IP (default) and Static IP. When the Static IP mode is selected, the user must provide some network properties. After changing the LAN mode, the Xtra.Beacon needs to be restarted for it to take effect. This can be done by temporarily removing the power from the device or by using the restart button on the System Tools webpage.

## LAN

<b>Mode:</b>	<input type="text" value="Dynamic IP (DHCP) v"/>
<b>IP address</b>	<input type="text" value="192.168.1.126"/>
<b>Subnet mask</b>	<input type="text" value="255.255.255.0"/>
<b>Default gateway</b>	<input type="text" value="192.168.1.1"/>
<b>DNS server</b>	<input type="text" value="192.168.1.1"/>

Figure 16 - LAN section of the setup webpage



The Static IP mode should only be selected by users with knowledge of the local network. Entering incorrect network properties may result in loss of access to the web interface and/or the Xtra.Beacon itself.

### 3.3.4 Change the Xtra.Beacon settings

In the Beacon settings section, the user can change the settings present in the Xtra.Beacon. This can be done by selecting values in the drop-down menus. The following settings can be changed through the webpage:

1. Function number: The function number which is sent to the Xtra.Sector Sensor.
2. Sector number: The sector number which is sent to the Xtra.Sector Sensor.
3. Beacon power: The power of the Xtra.Beacon signal.

## Beacon settings

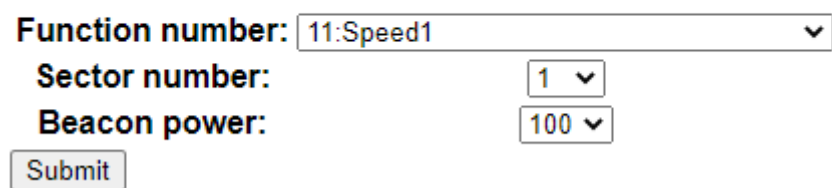

The screenshot shows a web form titled "Beacon settings". It contains three rows of settings, each with a label and a dropdown menu. The first row is "Function number:" with a dropdown menu showing "11:Speed1". The second row is "Sector number:" with a dropdown menu showing "1". The third row is "Beacon power:" with a dropdown menu showing "100". Below these settings is a "Submit" button.

Figure 17 - Xtra.Network section of the setup webpage



Changes to these settings should only be done with sufficient knowledge of the various settings of the Xtra.Beacon. Wrong settings can prevent the Xtra.Beacon from functioning properly.

### 3.3.5 Run Time Statistics

The Run Time Statistics webpage provides statistics for support purposes. When there is a problem with the Xtra.Beacon, a support employee of De Haardt can use this data to identify the issue.

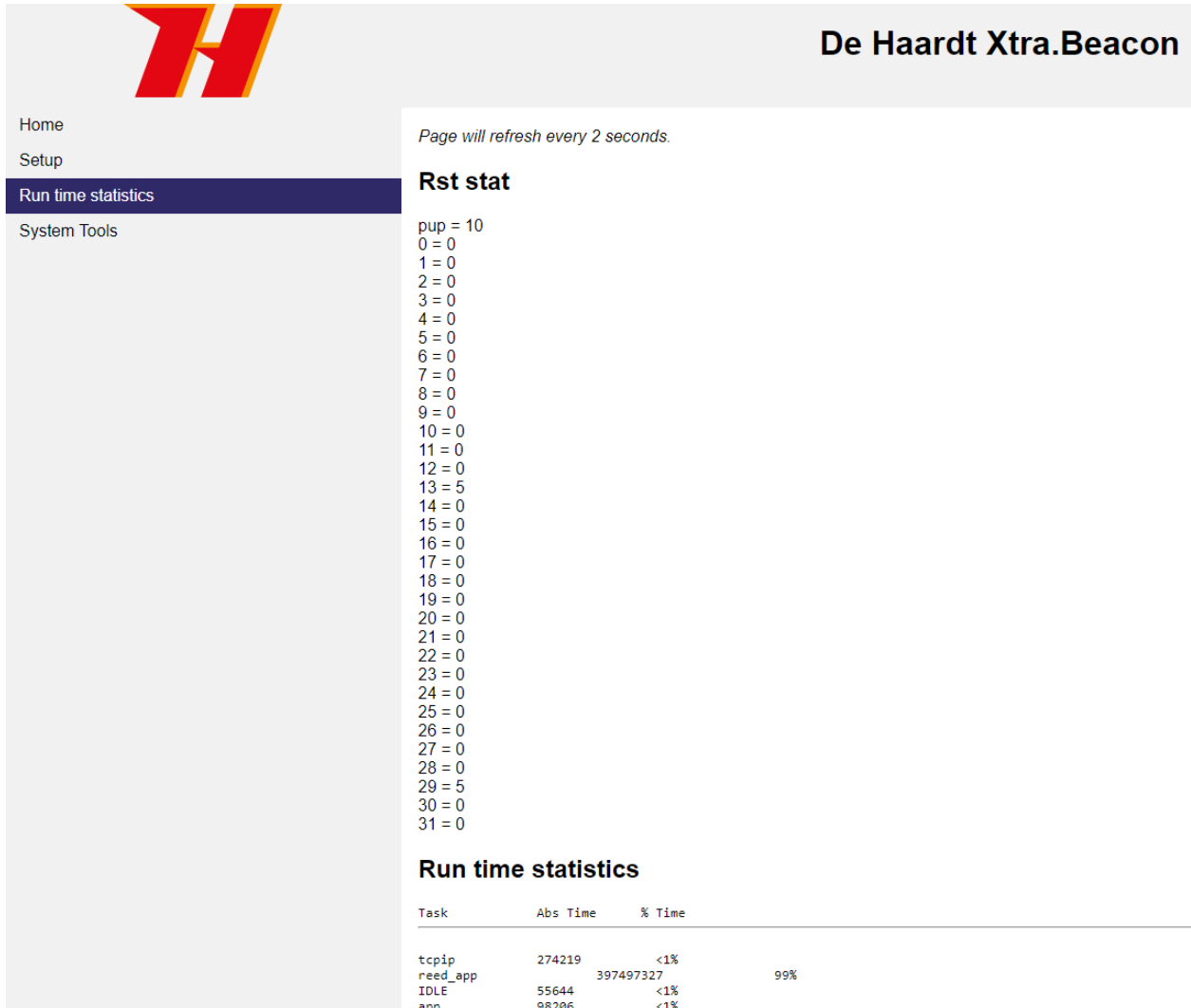

**De Haardt Xtra.Beacon**

Page will refresh every 2 seconds.

**Rst stat**

```
pup = 10
0 = 0
1 = 0
2 = 0
3 = 0
4 = 0
5 = 0
6 = 0
7 = 0
8 = 0
9 = 0
10 = 0
11 = 0
12 = 0
13 = 5
14 = 0
15 = 0
16 = 0
17 = 0
18 = 0
19 = 0
20 = 0
21 = 0
22 = 0
23 = 0
24 = 0
25 = 0
26 = 0
27 = 0
28 = 0
29 = 5
30 = 0
31 = 0
```

**Run time statistics**

Task	Abs Time	% Time
tcpip	274219	<1%
reed_app	397497327	99%
IDLE	55644	<1%
app	98206	<1%

Figure 18 - Run Time Statistics webpage

### 3.3.6 System Tools

The Systems Tools webpage allows the user to perform a firmware update. There are two options to upgrade to a new firmware version: perform a manual firmware update or check for online firmware updates.

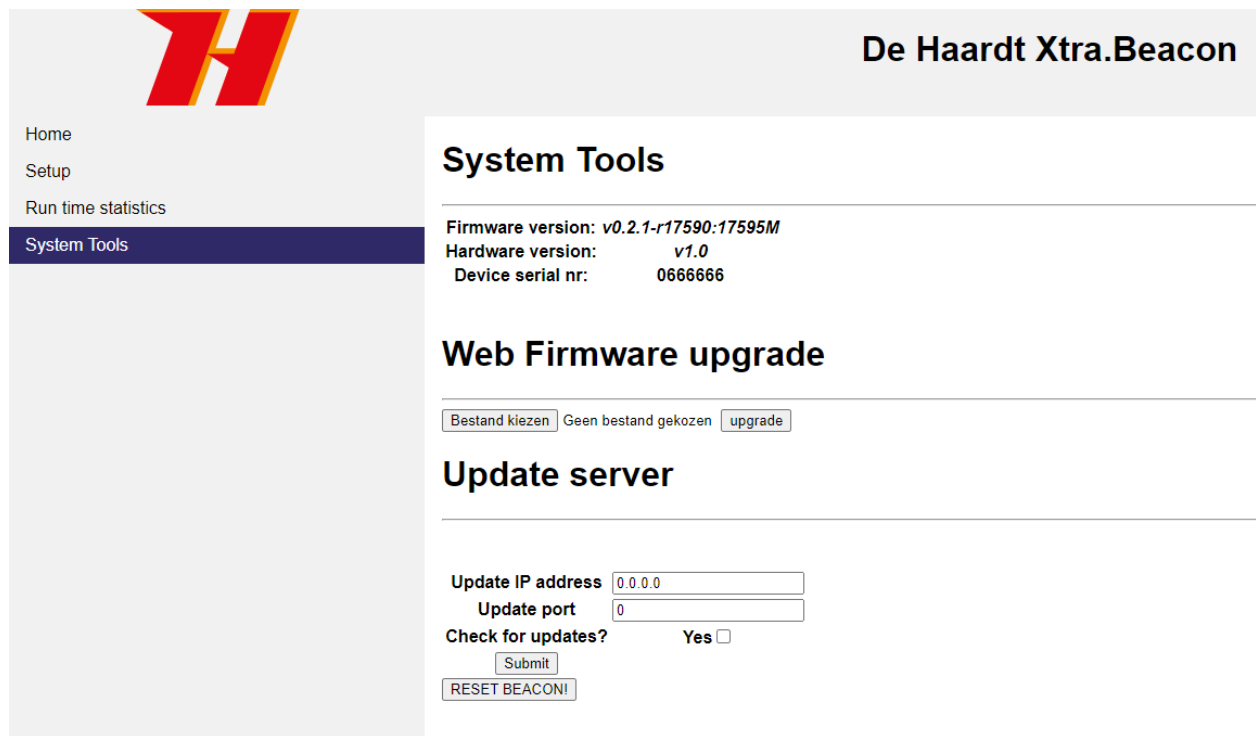

Figure 19 - System Tools webpage

#### 3.3.6.1 Perform a manual firmware update

A manual firmware update can be performed in the following way:

1. In the web firmware upgrade section, click the browse file button.
2. Select the firmware update file supplied by De Haardt using the File Upload window.
3. In the web firmware upgrade section, click the upgrade button.
4. Wait for the new firmware version to be downloaded.
5. Restart the Xtra.Beacon. This can be done by temporarily removing the power from the device or by using the restart button on the webpage.



Do not select any file that is not supplied by De Haardt. Doing so can cause the Xtra.Beacon to stop working.

## Web Firmware Upgrade

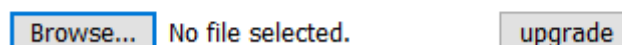

Figure 20 - Web Firmware Upgrade section of the Systems Tools webpage

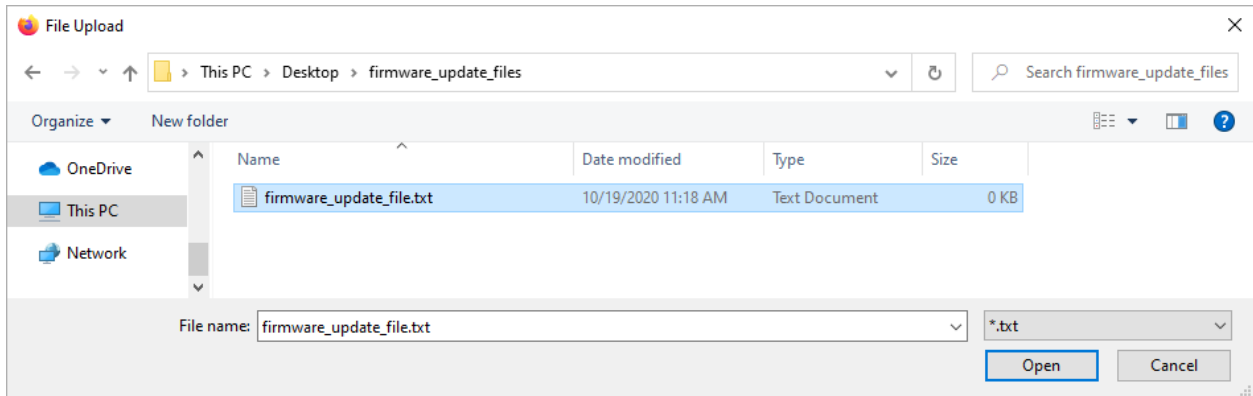



Figure 21 – File Upload window

 If the firmware update file is not displayed in the File Upload window, try changing the dropdown box above the “Open” and “Cancel” buttons to “All Files (\*.\*)”.

## Firmware downloading. Please wait!



Figure 22 - Firmware downloading

 Wait for the firmware download to complete or the Xtra.Beacon will not be updated.

### 3.3.6.2 Check for online firmware updates

When an online firmware update is available, the user will be notified by a support employee of De Haardt. The user can then have the Xtra.Beacon check for online firmware updates in the following way:

1. In the Update Server section, enter the update IP address and update port supplied by De Haardt.
2. Tick the checkbox to instruct Xtra.Beacon to check for updates.
3. Restart the Xtra.Beacon. This can be done by temporarily removing the power from the device or by using the restart button on the webpage.
4. If new firmware is available, it will be installed during the start-up of the Xtra.Beacon.



Internet access is required for the Xtra.Beacon to connect to the update server.

## Update server

---

<b>Update IP address</b>	<input type="text" value="0.0.0.0"/>
<b>Update port</b>	<input type="text" value="0"/>
<b>Check for updates?</b>	<b>Yes</b> <input type="checkbox"/>
<input type="button" value="Submit"/>	
<input type="button" value="RESET BEACON!"/>	

Figure 23 – Update Server section of the Systems Tools webpage

## 4 Technical specifications

This chapter describes the technical specifications of the Xtra.Beacon.

### 4.1 Specification overview

Description	Min	Typical	Max	Unit
Operational temperature	-10		55	°C
Input current			0.1	A
Radio frequency		125		KHz
IP code	IP65			

### 4.2 Water and dust resistance

The Xtra.Beacon is rated as an IP65 device.



De Haardt cannot be held responsible for water damage when:

- An Ethernet cable other than the one supplied is used.

### 4.3 Power over Ethernet

The Xtra.Beacon is in compliance with the IEEE 802.3af standard.



According to the standard, an Ethernet cable with a maximum length of 100 meters may be used. However, De Haardt recommends using the supplied 5-meter-long cable.



## 5 Support

For support, one can contact the support department of De Haardt by email: [support@de-haardt.com](mailto:support@de-haardt.com)